

Matala[®]
Make water alive

HAKKO

Linear Air Pumps



High Efficiency
Simple Maintenance
Completely Oil-Free

Overload Protection
Silent Operation
Long Life Expectancy

HK-20

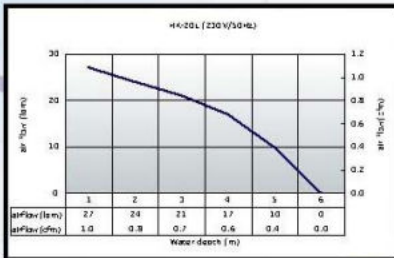

HK-40

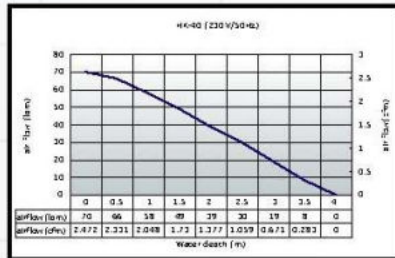

HK-60

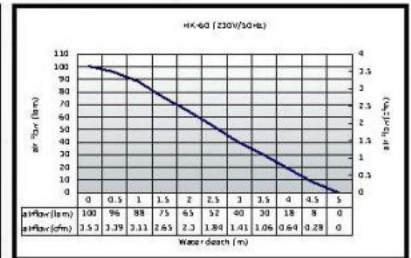

HK-80

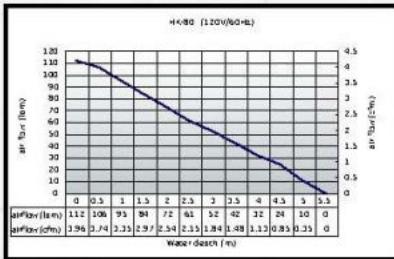

HK-100

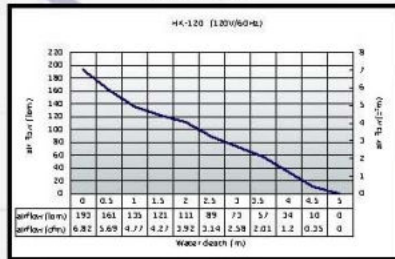

HK-120

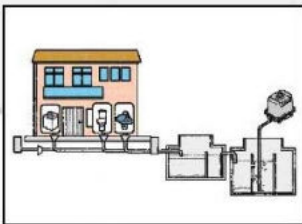
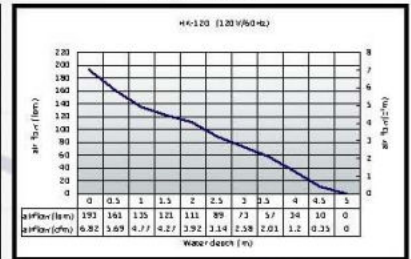

• Aeration for sewage treatment systems

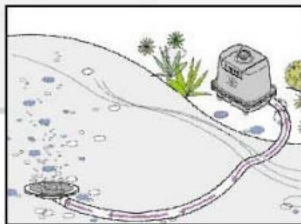

• Aeration for water garden pond

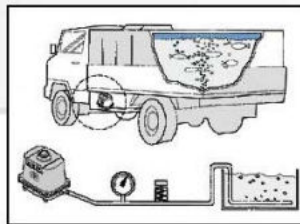

• Aeration for fish Transport

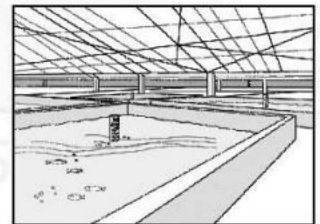

• Aeration for Aquaculture

Water depth (m)

HAKKO

Linear Air Pumps

LINEAR AIR PUMP PERFORMANCE CURVE
Pressure unit : water depth in meter

HK-20

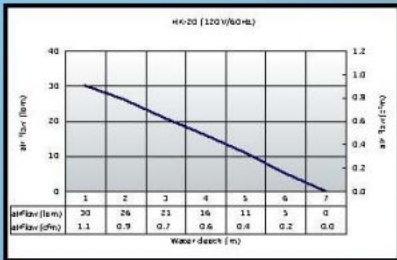

HK-40

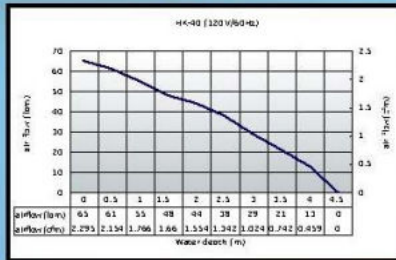

HK-60

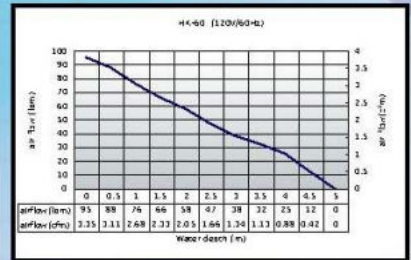

HK-80

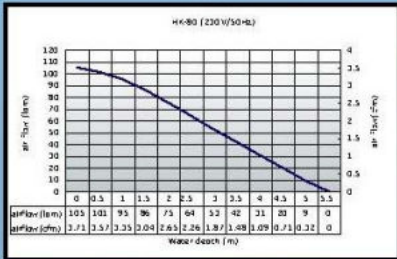

HK-100

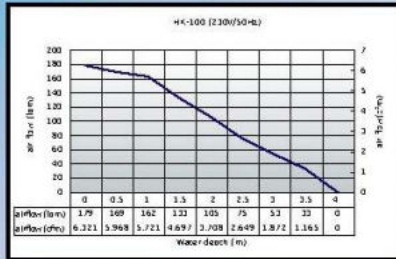

HK-120

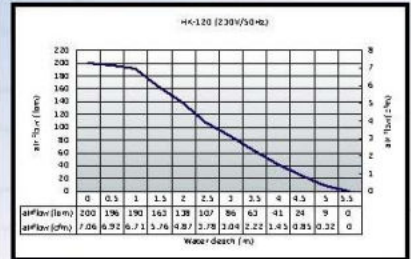

DIMENSIONS

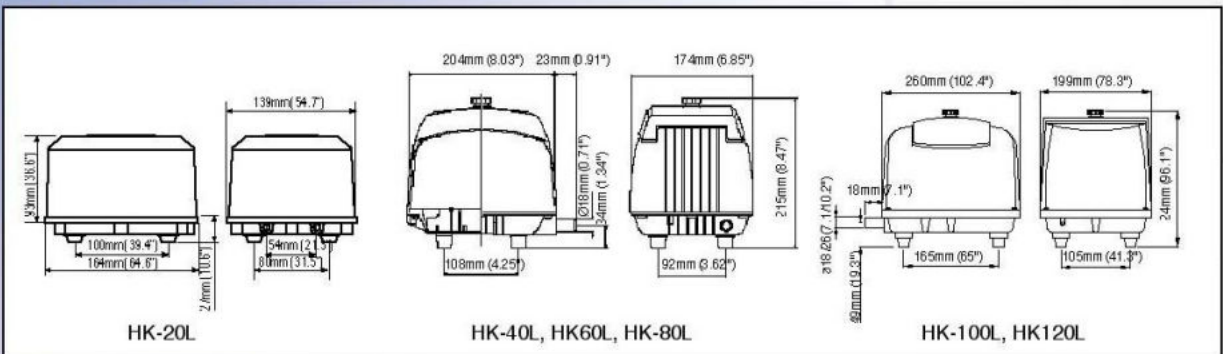

cfm) 3.35 3.11

HK-60 (120V/60Hz)

HAKKO *Linear Air Pumps*

SPECIFICATION

| Model | | HK-20 | HK-40 | HK-60 | HK-80 | HK-100 | HK-120 |
|-----------------------------|-----|---|---------------|---------------|-----------|---------------|---------------|
| SPECIFICATION Item | | | | | | | |
| Rated Voltage (V) | | AC 115 (AC 110/115/120 or AC 220/230/240) | | | | | |
| Power supply frequency (Hz) | | 50 / 60 | | | | | |
| Normal pressure (bar/psi) | | 0.1(1.42psi) | 0.13(1.85psi) | 0.15(2.13psi) | | 0.13(2.56psi) | 0.20(2.84psi) |
| Rated performance(lpm, cfm) | | 21 | 51 | 68 | 86 | 118 | 132 |
| Power (w) | | 17 | 40 | 63 | 85 | 116 | 126 |
| Noise level (dB) | | 32 | 35 | 38 | 38 | 40 | 42 |
| Closed pressure | bar | 0.26 | 0.38 | 0.46 | 0.54 | 0.45 | 0.54 |
| | psi | 3.7 | 5.5 | 6.7 | 7.8 | 6.5 | 7.8 |
| weight (kg) | | 2.9, 6.27 | 5.4, 11.9 | 6.3, 13.8 | 6.3, 13.8 | 8.9, 19.6 | 8.9, 19.6 |

*The above specifications are subject to change without prior notice.

DISTRIBUTED BY

